

BULLDOG SECURITY

Installation Manual

MODEL DELUXE 500



INSTALLATION TIPS AND ACCESSORIES

For most vehicles we have a T-Harness available to make your remote starter installation quicker and easier. To order call 1-800-659-0764 or visit us online at **www.directwholesale.net**.

Additional remote transmitters can be purchased through direct wholesale at **www.directwholesale.net**.

For a full list of Bulldog Security accessories visit our web site at **www.bulldogsecurity.com**.

Your Bulldog Security remote starter is equipped with an interactive install CD and installation kit. The kit will consist of a computer friendly test light, wire ties and a roll of tape. Use only the computer friendly test light or volt meter when testing and probing wires.

For Technical assistance **www.bulldogsecurity.com** can provide a detailed wiring diagram for your vehicle including additional helpful install tips.

JBS Technologies

225 Technology Way
Steubenville Ohio 43953

TABLE OF CONTENTS

INSTALLATION DIAGRAM	7-8
H1: 6 PIN HEAVY GAUGE WIRING CONNECTION	9
H1/1 Violet Wire – Starter Output	9
H1/2 & H1/3 Red Wire – +12V Power Input	9
H1/4 Yellow Wire – Ignition 1 Output	9
H1/5 Pink Wire – Ignition 2 Output	9
H1/6 Brown Wire – Accessory Output (Heater /ACC Output)	10
H2: 5 PIN WIRE HARNESS	10
H2/1 Red / White wire – Parking Light Relay Power Input	10
H2/2 White wire – Parking Light Relay Output	10
H2/3 Black wire – System Ground	10
H2/4 Brown wire – (-) 200ma Horn Output	11
H2/5 Red wire – System Power	11
H3: BLACK 4-PIN CONNECTOR	
FOR TWO-WAY TRANSCEIVER/ANTENNA MODULE	11
H5: 9 PIN BLACK WIRE HARNESS	11
H5/1 Grey wire – (-) Negative Safety Shut Down For Hood Pin Switch	11
H5/2 Brown / Red wire – (+) Positive Safety Shut Down Brake or Handbrake	12
H5/3 Black / White wire – (-) Neutral Safety Switch or (-) Remote Toggle Switch Input	13
H5/4 Blue /White wire – Not Used	13
H5/5 Grey / Black wire – (-) Diesel Wait - To - Start Input	13
H5/6 Green wire – (-) Negative Door Pin Switch Input (Zone 3)	13
H5/7 Violet Wire – (+) Positive Door Pin Switch Input (Zone 3)	14
H5/8 White / Black wire – (-) Instant Start & Turn Off Input	14
H5/9 Violet / White wire – Tach Input or Oil Sensor Connection	14-15
H6. 6 PIN DOOR LOCK CONNECTOR	15
Installing New Door Lock Actuator	15
Type “A” Negative Trigger Door Lock System	15
Type “B” Positive Trigger Door Lock System	15
Type “C” 5-wire Door Lock System	15
2 Steps Door Unlock Wire Connection	
Type “C” 5 Wires Alternating Door Lock System	16
Vacuum Operate Door Locking System	16
2 Steps Door Unlock Wire Connection	
Type “B” Negative Switched Door Lock System	16

TABLE OF CONTENTS

2 Steps Door Unlock Wire Connection	
Type "A" Positive Switched Door Lock System	16
H7: 10-PIN WHITE WIRE HARNESS	17
H7/1 Blue /Black wire - (-) 200mA Ignition 3 Control Output.....	17
H7/2 Black / Violet wire - (-)	
200mA Channel 6 Programmable Output.....	17
H7/3 Brown / Black wire - (-) 200mA Programmable Output	17
Horn Output - (Factory Default Setting)	
Factory Security Rearm Signal Output	
H7/4 Black / White wire - (-) 200mA	
Dome Light Supervision Output	18
H7/5 Black / Red wire - (-) 200mA	
Channel 5 Programmable Output	18
H7/6 Violet / Black wire - (-) 200mA Programmable Output	18
Channel 4 Programmable Output - (Factory Default Setting)	
Ground Output During Start (Crank)	
H7/7 Red / White wire - (-) 200mA Channel 3 (Trunk) Output.....	19
H7/8 LT. Green / Black wire - (-) 200mA Programmable Output.....	19
Dual Pulse Door Unlock Output	
Factory Security Disarm Signal Output (Factory default setting)	
Start Status (Shock Sensor By-Pass Control) Output.....	19
H7/9 Orange / White wire -(-)	
200mA Grounded Output When Disarmed	20
H7/10 Orange wire - (-) 200mA Grounded Output When Armed	20
H8. 2 PIN BLUE CONNECTOR FOR THE VALET SWITCH	20
H9. 2 PIN WHITE CONNECTOR	
FOR THE LED STATUS INDICATOR	20
PROGRAMMING & TESTING:	
A. AUTOMATIC / MANUAL TRANSMISSION VEHICLE	21
B. PROGRAMMING A NEW TRANSMITTER	21
C. FEATURES PROGRAMMING	21-22
Alarm Feature #1 Programming	22-23
3 / 30 seconds Delay Door Ajar Error Chirp	
Alarm Feature #2 Programming	23-24
Comfort Feature	
Alarm Feature #3 Programming	24-26
Channel 4 (5 / 6) Timer Control Output Programming	
Ground Output During Start (Crank) Programming	

TABLE OF CONTENTS

Start Feature #1 Programming	27-28
Safe Start (Child Safety Mode)	
Temperature Start Programming	
Start Feature #2 Programming	28-29
Engine Checking TACH. – RPM Learning & Testing	30
Engine Checking Voltage – Start Timer Set-up & Testing	31
Engine Checking Oil Sensor – Start Timer Set-up & Testing	32
Turbo Mode	
Range Check	
RETURN TO FACTORY DEFAULT SETTING	33
SHUTDOWN DIAGNOSTICS.....	34-35
TESTING YOUR INSTALLATION	35-39
Test the Brake shutdown circuit	
Test the Hood Pin shutdown circuit	
Neutral Start Safety Test	
Mechanical Neutral Safety Switch Considerations	
Park/Neutral ECM Input	
Key In Sensor Circuits	

IMPORTANT NOTICE

This remote starter with keyless entry system is designed to be installed on fuel injected vehicles only.

- This system must be installed and wired through a safety switch to assure that it will not start in any forward or reverse gear.
- Some automatic transmission vehicles [mainly older GM models with a purple starter wire] have a mechanical-type park mechanism instead of an electrical safety switch. The mechanical type does not interrupt the starter circuit when the transmission is any gear and does not offer the 100% level of safety required for remote starting purposes. Therefore, you must create a circuit that will prevent the remote starter from engaging when the key is in the ignition.
- Once you install this system, you must verify that the vehicle will not start any forward or reverse gear.

IMPORTANT NOTICE

- Read the operation manual for operating and programming routine.
- Do not install any component near the brake, gas pedal or steering linkage.
- Most vehicles have an SRS air bag system. Use extreme care and do not probe any wires of the SRS system. These wires will almost always be located inside a bright yellow tube located near the steering wheel column.
- Check behind panels before drilling any holes. Ensure that no wiring harness or other components are located behind the panels that would otherwise be damaged.
- Do not use conventional crimp lock or bullet connectors on any wiring.
- Do not disconnect the battery if the vehicle has an anti-theft radio or is equipped with an airbag. Doing so may cause a warning light to be displayed and the radio to stop functioning.
- Do not leave the interior or exterior lights on for an extended period of time. Remove the dome light fuse from the vehicles fuse box.
- Do not mount the control module until all connections have been made and the unit is programmed and tested.
- Finally place the warning sticker under the hood when the installation is completed.

COMPONENTS

- 1- Main Control Module
- 1- Five Button LCD Remote Transmitter
- 1- 6 Pin Ignition Harness
- 1- 5 Pin Harness
- 1- 10 Pin Mini Output Harness
- 1- 9 Pin Mini Input Harness
- 1- 2 Pin Valet Switch
- 1- 2 Pin Led Light Harness
- 1- 4 Pin Antenna Harness
- 1- 6 Pin Door Lock Harness
- 1- Hood Switch
- 1- Hood and Window Decal
- 1- Installation Manual
- 1- Owners Manual

INSTALLATION DIAGRAM

VIOLET Wire Loop:
This Loop is used to Select between an Automatic/Manual Transmission vehicle

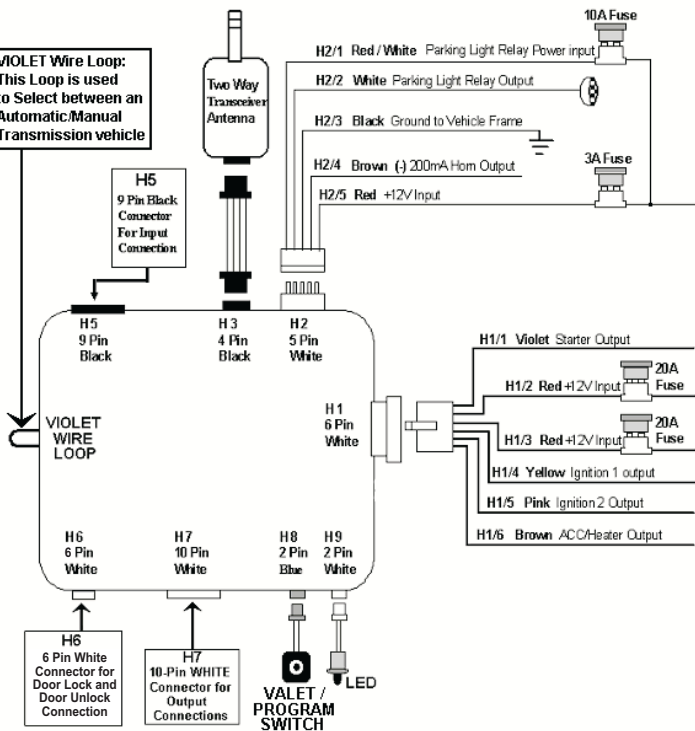

WIRING HARNESSSES

H5 9-Pin BLACK Harness

H5/1	GREY (-) Negative Safety Shut Down for Hood pin switch
H5/2	BROWN/RED (+) Positive Safety Shut Down for Brake
H5/3	Thin BLACK (-) Neutral Safety switch or (-) Remote toggle switch input
H5/5	GREY/BLACK (-) Diesel Wait to start wire input
H5/6	GREEN (-) Negative Door pin input
H5/7	VIOLET (+) Positive Door pin input
H5/8	WHITE/BLACK (-) Instant Start and Turn off input
H5/9	VIOLET/WHITE Tach input or Oil sensor connection

IMPORTANT NOTE: Directly connect the H6/3 Thin BLACK (-) wire to ground when this wire is not used.

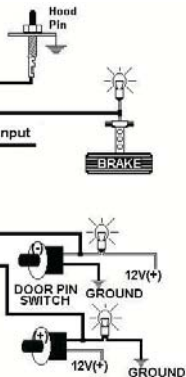

H7 10-Pin WHITE Harness

H7/1	BLUE/BLACK (-) 200mA Ignition 3 Control Output	
H7/2	BLACK/VIOLET (-) 200mA Channel 6 Programmable Output	
H7/3	BROWN/BLACK(-) 200mA Programmable Output	1. Horn Output (factory default setting) 2. Factory Security rearm Out.
H7/4	BLACK/WHITE (-) 200mA Domelight Supervision Output	
H7/5	BLACK/RED (-) 200mA Channel 5 Programmable Output	
H7/6	PURPLE/BLACK (-) 200mA Programmable Output	1. Channel 4 Programmable out (factory default setting) 2. Ground output during start (crank)
H7/7	RED/WHITE (-) 200mA Channel 3 (Trunk) Output	
H7/8	LT. GREEN/BLACK (-) 200mA Programmable Output	1. Dual pulse door unlock output (factory default setting) 2. Factory disarm signal output 3. Start Status (shock sensor by-pass control) Output
H7/9	ORANGE/WHITE (-) 200mA Grounded output when disarmed	
H7/10	ORANGE (-) 500mA Grounded Output when armed	

Keep all wiring away from moving engine parts, exhaust pipes and high-tension cable. Tape wires that pass through holes on the firewall to prevent fraying. Watch out for sharp edges that may damage wires and cause short circuits.

CAUTION: Do not connect the wire harness to the control module until all wiring to vehicle is complete.

WIRING CONNECTIONS

H1: 6-PIN HEAVY GAUGE WIRING CONNECTIONS:

Remember that the system is designed to duplicate the same functions of the ignition key switch! Since this installation will require analysis of the ignition switch functions, we recommend making the H1 harness connections directly to the ignition switch wires.

H1/1 VIOLET Wire—(Starter Crank Output)

Connect the **VIOLET** wire to the starter crank wire at the ignition switch harness. This wire show **+12 volts** when the ignition switch is turned to the "**start**" or "**crank**" position only. This wire will test **0 volts** in all other ignition switch positions.

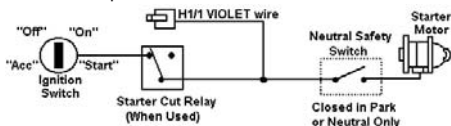

H1/2 and H1/3 RED Wires (2)-(+12V Power Input)

Remove the **two 20A** fuses prior to connecting these wires and do not replace them until the satellite harness has been plugged into the control module. These two wires are the source of current for all the circuits the relay satellite will energize. They must be connected to a high current source. Since the factory supplies **(+)** **12V** to the key switch, it is recommended you make your connections there.

Note: If the factory supplies two separate **(+)** **12V** feeds to the ignition switch, connect one **RED** wire of the satellite to each feed at the switch.

H1/4 YELLOW Wire – (Ignition 1 Output)

Connect the **YELLOW** wire to the ignition one wire from the ignition switch. The ignition wire should receive "**12 volts**" when the ignition key is in the "**on**" and "**start**" or "**crank**" positions. When the ignition is turned "**off**", the ignition wire should receive "**0**" voltage. **The YELLOW wire must be connected.**

H1/5 PINK Wire – (Ignition 2 Output)

Some vehicles have 2 ignition wires that must be connected. Attach the **PINK** wire to the ignition 2 wire from the ignition switch. The ignition wire should receive "**+12 volts**" when the ignition key is in the "**on**" or "**run**" and "**start**" or "**crank**" positions. When the ignition is turned to the "**off**" position this wire will show "**0**" voltage. If the **PINK** wire is not used, cap or tape the end of the wire.

WIRING CONNECTIONS

H1/6 BROWN Wire –Accessory Output (Heater /AC Output)

Connect the **BROWN** wire to the Accessory/Heater-Blower wire in the vehicle that powers the Heater/AC system. The Accessory/Heater-Blower wire will show **+ 12 volts** when the ignition switch is turned to the **"accessory"(some vehicle) "on" and "run"** positions, and will show **"0"** volts when the key is turned to the **"off" and "start" or "crank"** positions. On some vehicles, there will often be more than one Accessory/Heater-Blower wire in the ignition harness. The correct Accessory/Heater-Blower wire will power the vehicle's Heater/AC system. **Note:** Some vehicle may have separate wires for the blower motor and the air conditioning compressor such as Ford products. In such cases, it will be necessary to add a relay to power the second Accessory/Heater-Blower wire, if your vehicle does not have a Ignition 2 wire, use the Ignition 2 Output (**H1/5 PINK**) wire from the remote starter to power up the second Accessory/Heater-Blower wire.

H2: 5-PIN WIRE HARNESS:

H2/1 RED / WHITE Wire (Parking Light Relay Input)

The **RED/WHITE** wire is the **input for the parking light relay**. This wire will determine the output polarity of the parking light relay. If your vehicle requires **+12volts** to power the parking light circuit you will not need to connect this wire. This wire is already connected to the **+12 volt** constant **RED** wire in the same harness. If your vehicle's parking light circuit operates on a switched **(-) negative** ground then cut the **RED/WHITE** wire from the **RED** wire and attach it directly to a **ground** source. **Note:** Make sure to tape the **RED** wire at the cut location.

H2/2 WHITE Wire (Parking Light Relay Output)

Connect the **WHITE** wire to the wire that powers the **parking light circuit** on the vehicle. The **WHITE** parking light wire is rated at 10amps max and should not exceed this current. If your vehicles parking light system requires more than **10amps you must add a relay** to power the parking light system.

H2/3 BLACK Wire (System Ground)

This is the main ground connection of the control module. Make this connection to a solid section of the vehicles frame **ground**.

WIRING CONNECTIONS

H2/4 BROWN Wire (Horn Output)

The **BROWN** wire will provide a (-) **negative** output for the vehicles horn or optional siren hookup. This wire is a transistorized low current 200mA output, and should only be connected to the low current ground output from the vehicle's horn switch.

H2/5 RED Wire (System +12volt Constant Power)

Connect the **RED** wire to a constant **+12 volt** source.

H3: 4-PIN BLACK CONNECTOR (Windshield Receiver / Antenna)

The windshield receiver/antenna mounts on the inside of the front windshield. We suggest you mount it on the lower left or upper left-hand side of windshield.

Warning! Do not mount in such a manner that it obstructs the driver's view.

- The receiver/antenna whip must be vertical.
- Remove the protective tape backing and clean the area around the glass where you are installing.
- Carefully align the receiver/antenna and apply to windshield.
- Route the black connector wire behind the trim and connect to receiver/antenna.
- Connect the other end to the control module.
- Special considerations must be made as some newer vehicles utilize a tinted window glass that can effectively reduce the range.

H5 9-PIN BLACK WIRING HARNESS:

H5/1 GREY Wire (-) (Negative Safety Shut Down For Hood Switch)

This wire provides an instant shutdown for the remote start, whenever it is grounded. Connect the wire to the hood pin switch previously installed. This wire must be routed through a grommet in the firewall and connected to the hood pin switch. If the pin switch is to be used with an alarm system, connect this wire with diode.

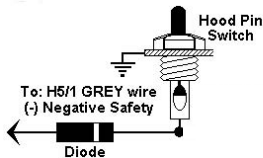

WIRING CONNECTIONS

H5/2 BROWN/RED (Positive Safety Shut Down or Brake Input)

This wire provides an instant shutdown for the remote starter whenever it receives a **+12volts**. Connect this wire to the output or cold side of the brake switch that shows **+12volts** only when the brake is pressed. See below diagram

This wire provides an instant shutdown for the remote start, whenever it receives **+12volts**. If the brake lights switch in the vehicle switches **+12 volts** to the brake light circuit, connect this wire to the output side of the brake switch. This will allow the remote start to shut down if an attempt is made to operate the vehicle without the key while running under the control of the remote start. In most vehicles, in order to shift gear, the brake pedal must be depressed. The brake input will in turn cause the remote start unit to shut off. (See diagram.)

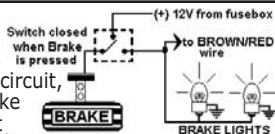

Manual Transmission: When you are in manual transmission gear mode, you also need to connect the **BROWN / RED** wire into the handbrake switch. An isolation diode must be used for handbrake switched light circuits and brake light circuit. Most handbrake wire will show **+12V** at rest when the ignition is on and ground when you set the handbrake. However, if the handbrake wire shows **0V** while the handbrake is at rest, you will need to add a relay as below.

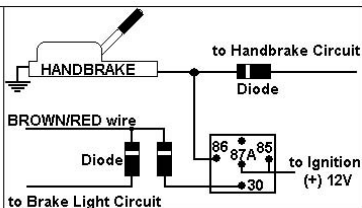
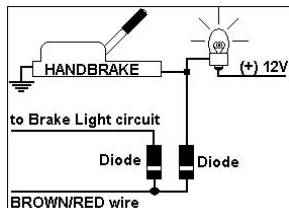

WIRING CONNECTIONS

H5/3 THIN BLACK Wire (Remote Start Enable or Neutral Safety Input)

When the **THIN BLACK** wire is grounded, the remote start unit is operable. When this wire is open from ground, the remote starter is disabled.

1. The optional "remote start toggle switch" can be added on to this wire to temporarily disable the remote starter. This feature is useful if the vehicle is being serviced or stored in an enclosed area.
2. This wire can also be connected to the neutral safety switch wire in the vehicle.

IMPORTANT NOTE: Directly connect the THIN BLACK wire to ground when not being used. The remote starter will not start if this wire is not grounded.

H5/4 BLUE / WHITE Wire (Not Used)

H5/5 GREY/BLACK (Negative Diesel Wait to Start Input)

The **GREY/BLACK** wire is a (-) **negative** input for diesel vehicles only. This wire will attach directly to the wait to start bulb on the dashboard, or on some vehicles the ECM module. You must locate and test the wire that will provide a ground signal when the wait to start light is on. The correct wire will provide a (-) **negative** ground signal when the bulb is on and **+12volts positive** when the bulb is out. There are some vehicles that will have the opposite configuration and you will need to wire a relay to convert the polarity. (**See diagram example below**) You must program the control module for diesel mode. (**See programming instructions.**)

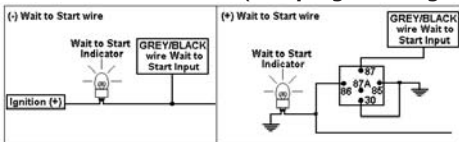

H5/6 GREEN (Negative Door Input) (Must be used for manual transmissions)

The **GREEN** wire is the (-) **negative** ground trigger input for negative style door circuits. This green wire will attach to the wire in the vehicle that provides a (-) **negative** ground when any of the doors are opened. The same wire in the vehicle will provide **+12volts positive** or **0 voltage** when the doors are closed.

WIRING CONNECTIONS

H5/7 VIOLET (Positive Door Input) (Must be used for manual transmissions)

The **VIOLET** wire is the positive trigger input for **+12volt positive** style door circuits. The **VIOLET** wire will attach to the wire in the vehicle that provides **+12volt positive** when the door is opened. The same wire in the vehicle will provide **0 voltage** or **negative** ground when the doors are closed. This type of door circuit is most common with **Ford** vehicles.

H5/8 WHITE/BLACK (Instant Start and Stop Input)

The **WHITE/BLACK** wire will activate and deactivate the remote starter when it sees a momentary **(-) negative** ground.

This wire is used for testing purposes and to activate the remote starter from another source. **(See Alarm Feature #3 Programming Chart)**

H5/9 VIOLET / WHITE Wire (Tach. Input or Oil Sensor Connection) (Tach Input Connection)

Note: No connection of this wire is required, if you are using the voltage checking type mode. This input provides the remote start system with information about the engine's revolutions per minute (RPM). It can be connected to the **(-) negative** side of the coil in vehicle with conventional coils. To test for a tachometer wire, a multi-meter capable of testing **AC voltage** must be used. The tach wire will show between **1V** and **6V AC** at idle, and will increase as the engine RPM increases. In multi-coil ignition systems, the control module can learn individual coil wires.

IMPORTANT! Do not test for tach wires with a test light or logic probe. How to find a tach wire with your multi-meter

1. Set the ACV or AC voltage (12V or 20V is fine.)
2. Attach the (-) probe of the meter to chassis ground.
3. Start and run the vehicle.
4. Probe the wire you suspect of being the tach wire with the red probe of the meter.
5. If this is the correct wire the meter will read between 1V and 6V.

IMPORTANT NOTE: You must program the "Tach Signal" before trying to remote start.

Oil Sensor Signal Connection

Locate the wire connected to the oil sensor.

Negative Oil Sensor Connections: +12volts to **+14volts** will show on the multimeter when the ignition switch is turned to the **"ON"** position in the key cylinder and **+2volts** to **+3volts** when the motor is running. 14

WIRING CONNECTIONS

Positive Oil Sensor Connections: +2volts to + 3volts will show "ON" the multimeter when the ignition switch is turned to the "on" position in the key cylinder and **+12volts to + 14volts** when the motor is running.

IMPORTANT NOTE: You must program for oil sensing type before trying to remote start. (See programming start feature #2.)

H6: 6-PIN DOOR LOCK CONNECTOR:

H6 WHITE 6-Pin Door Lock Harness

H6	H6/1 BLUE/RED Wire (87A) Door Unlock Relay Output
	H6/2 BLUE/WHITE Wire (30) Door Unlock Relay Output
	H6/3 BLUE/YELLOW Wire (87) Door Unlock Relay Input
	H6/4 GREEN/RED Wire (87A) Door Lock Relay Output
	H6/5 GREEN/WHITE Wire (30) Door Lock Relay Output
	H6/6 GREEN/YELLOW Wire (87) Door Lock Relay Input

Adding New Actuator

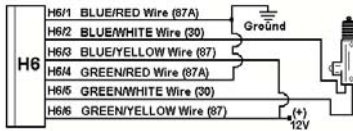

Type "A" Positive Trigger

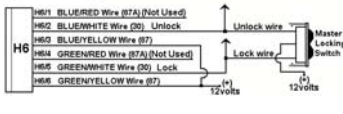

Type "B" Negative Trigger

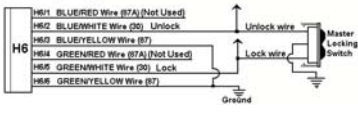

Type "C" 5-wire Locks

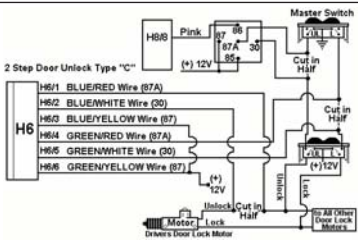
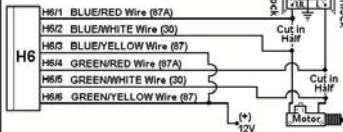

WIRING CONNECTIONS

VACUUM OPERATED DOOR LOCKING SYSTEM: TYPICAL OF MERCEDES BENZ AND AUDI.

Locate the wire under the driver's kick panel. Use the voltmeter connecting to ground, verify that you have the correct wire with the doors unlocked, the voltmeter will receive "12 volts". Lock the doors and the voltmeter will read "0 volt". Move the alligator clip to +12V and the voltmeter will receive "+12 volts". Cut this wire and make your connections. Be sure to program the door lock timer for 3.5 seconds.

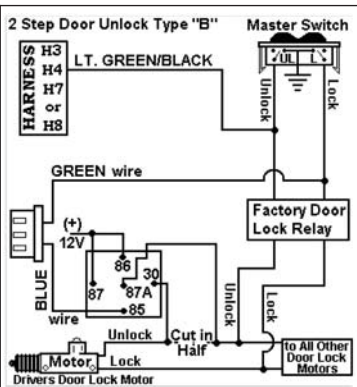
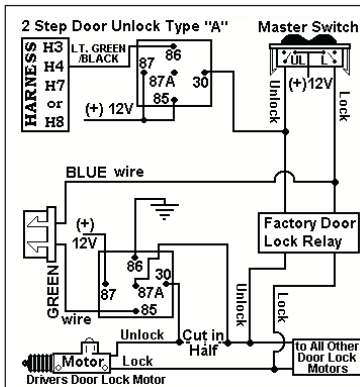
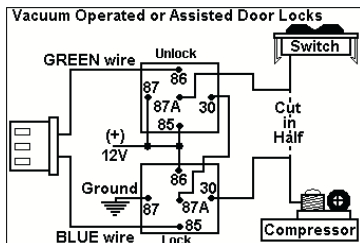

WIRING CONNECTIONS

H7: 10-PIN WHITE WIRING HARNESS:

H7/1 BLUE / BLACK Wire (Ignition 3 Output)

This wire provides a **200mA (-) negative** ground output that becomes active 4 seconds before the remote start unit initializes, and remains grounded while running.

Ignition 3 output:

Some newer vehicles use a third ignition wire which is required to start and keep the vehicle's engine running. If this is the case, wire an IGN 3 relay (not supplied) as shown: Do not connect any vehicle circuits together, they are isolated for a reason.

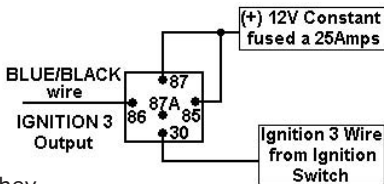

H7/2 BLACK/VIOLET (Timer Control Channel 6 Programmable Output)

The **BLACK/VIOLET** wire provides a 200mA (-) programmable (-) **negative** ground output for a variety of optional devices. The output on the **BLACK/VIOLET** wire is programmable from 1 to 120 seconds. (See **Alarm Feature #3 Programming Chart.**)

This wire can be used to open a sunroof, or any power device you choose to control. The **BLACK/VIOLET** wire must be wired to a relay when powering any devices.

Note: factory default setting is a 1 second momentary (-) negative output. (See Alarm Feature #3 Programming Chart.)

To activate this feature press the transmitter * and % buttons at the same time.

H7/3 BROWN/BLACK (Factory Rearm Output)

The **BROWN/BLACK** wire provides a 200mA (-) **negative** output for hooking up to the vehicles factory rearm wire. For factory rearm a (-) **negative** pulse is provided after the remote starter times out or is shut down with the transmitter.

WIRING CONNECTIONS



H7/4 BLACK/WHITE (Dome Light Supervision Output)

The **BLACK/WHITE** wire provides a 200mA (-) **negative** output for 30 seconds when the doors are unlocked using the transmitter. The **BLACK/WHITE** wire will also flash the dome light circuit for the same duration as the siren when violated. **Note: If not attaching the BLACK/WHITE wire directly to the BCM (Body control module) a relay must be used to power the dome light circuit.**

H7/5 BLACK/RED (Timer Control Channel 5 Programmable Output)

The **BLACK/RED** wire provides a 200mA (-) **negative** programmable ground output for a variety of optional devices. The output on the **BLACK/RED** wire is programmable from 1 to 120 seconds. **(See Alarm Feature #3 Programming Chart)**

This wire can be used to open a sunroof, or any power device you choose to control. The **BLACK/RED** wire must be wired to a relay when powering any devices. **Note: factory default setting is a 1 second momentary ground. (See Alarm Feature #3 Programming Chart)**

To activate this feature press the transmitter  and  buttons at the same time.



H7/6 VIOLET/BLACK (Timer Control Channel 4 / Key Sensor Output)

The **VIOLET/BLACK** wire provides a 200mA (-) **negative** programmable ground output for a variety of optional devices. The output on the black/violet wire is programmable from 1 to 120 seconds. **(See Alarm Feature #3 Programming Chart)**

This wire can be used to open a sunroof, or any power device you choose to control. The **VIOLET/BLACK** wire must be wired to a relay when powering any devices.

Note: factory default setting is a 1 second momentary ground. (See Alarm Feature #3 Programming Chart)

Note: this wire can also be programmed as a second start crank output. . (See Alarm Feature #3 Programming Chart)

Some vehicles require a second starter wire to be energized, or on certain GM vehicles what is known as the **bulb check** wire must receive a ground signal while the starter is cranking. When using this wire as a second start wire (Most Nissan vehicles) a relay must be used to energize this circuit. Press the transmitter  and  buttons at the same time.

WIRING CONNECTIONS

H7/7 RED/WHITE (Channel 3 Trunk Output)

The **RED/WHITE** wire will provide a 1 second 200mA **(-) negative** ground pulse output by activating channel 3 on the transmitter for 2 seconds. This feature will allow trunk release or other optional devices by remote transmitter. **Note: If not attaching the RED/WHITE wire directly to the BCM (Body control module) a relay must be used to power the trunk or device being energized.**

H7/8 LT. GREEN / BLACK Wire (Step 2 Door Unlock / Factory Disarm / Shock sensor Bypass) Dual Pulse Door Unlock Output –

The dual pulse door unlock feature will work for the most fully electronic door lock circuits. When wired for this feature, pressing the disarm (or unlock) button one time will disarm the alarm and unlock the driver's door only. If you press disarm (or the unlock) button two times within 3 seconds, the alarm will disarm and all the doors will unlock. **(See Alarm Feature #3 Programming Chart.)**

Factory Security Disarm Signal Output – (Factory Default Setting)

This wire is designed to disarm a factory installed security system. This wire sends a **(-) negative** 1 second pulse upon a remote start and remote door unlocking. Some factory systems must be disarmed to allow remote starting. In most cases, this wire may be connected directly to the factory alarm disarm wire. The correct wire will show negative ground when the key is used to unlock the doors or trunk. This wire is usually found in the kick panel area in the wiring harness coming into the car body from the door. **(See Alarm Feature #3 Programming Chart)**

Start Status (Shock Sensor By-Pass Control) Output–

This wire is designed to by-pass a shock sensor module. This wire will supply an output at all times the remote start is operating plus an additional 3 seconds after the remote start unit turn off. **(See Alarm Feature #3 Programming Chart.)**

WIRING CONNECTIONS

7/9 ORANGE/WHITE (Ground Output When Disarmed)

The **ORANGE/WHITE** wire provides a 200mA (-) **negative** output when the security system is disarmed. This output can be used for activating optional devices such as memory positions for power seats.

Note: If not attaching the orange/white wire directly to the BCM (Body control module) a relay must be used to power the device being energized.

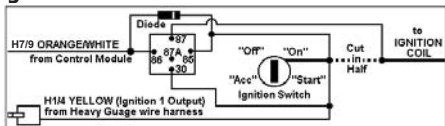

H7/10 Orange (Starter Disable Relay Output)

The ORANGE will provide a 500mA (-) **negative** output when the security system is armed. A relay with a diode across the coil must be used when interrupting the starter wire. If attaching more than one device to this wire you must diode isolate each device.

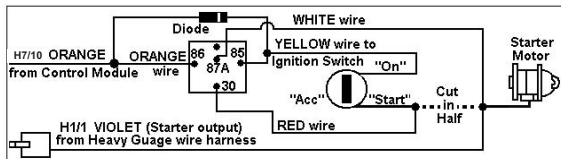

H8: 2-PIN BLUE CONNECTOR FOR THE PROGRAM / VALET SWITCH:

Select a mounting location for the switch that is hidden but easily accessible to the driver of the vehicle. Mount the valet switch in a hidden but accessible location. Route and plug in the valet switch wires to the control module.

H9: 2-Pin White Connector

The LED light should be mounted in a highly visible location in the dashboard, center console or dashboard face. Provide for at least a 6mm space behind the LED light. Once a suitable location is chosen, drill a 6mm hole then press the LED housing into the hole. Route the LED wires to the control module and plug it in.

PROGRAMMING AND TESTING

A. Manual Transmission: When you are in manual transmission gear mode, you also need to connect the **Brown / Red** wire to the emergency or handbrake switch. An isolation diode must be used for handbrake circuit and brake light circuit. Most handbrake wires will show **+12V** at rest when the ignition is on and ground when you set the handbrake. However, if the handbrake wire shows **0V** while the handbrake is at rest, you will need to add a relay as shown in the diagram below.

Automatic transmission gear vehicle: Uncut (leave intact) the **"Violet Loop Wire"**.

Manual transmission gear vehicle: Cut the **"Violet Loop Wire"** and tape the end.

Note: The system is not recommended for the manual transmission gear vehicles with removable tops.

Note: When installing this system on a vehicle with manual transmission the following must be hooked up:

1. **"Brake Light Circuit"** and **"Handbrake Circuit"**. (See **H5/2 BROWN/RED** wire connection.)
2. Negative door pin switch (see **H5/6 GREEN** wire connection.) or positive door pin switch (see **H5/7 VIOLET** wire connection.)

Note: Vehicles with a manual transmission gear must use "Engine Checking Tach." Or "Engine Checking Oil Sensor." only. (See Start Feature Programming # 2 - 2)

B. PROGRAMMING A NEW TRANSMITTER:

Note: The control module will only retain the last 4 remote transmitters programmed. If the transmitter memory is exceeded, the security system will start deleting transmitters from memory in chronological order.

1. Turn the Ignition switch from **"OFF"** to **"ON"** **3 times** and stay in the **"ON"** position.
2. **Within 15 seconds**, push the **valet/program switch 3 times** and on the **3rd push hold it** in until a long chirp from horn and the LED start to flash then release the **valet/program switch**. You are now in the **transmitter programming mode**.
3. Press and hold any button on the transmitter until **(1) chirp** from the horn and **(1) flash** from the parking lights confirming the first transmitter is now programmed.
4. If you have additional transmitters **(up to 4)** that need to be programmed, repeat step 3 for each transmitter.

PROGRAMMING AND TESTING

Exit: Turn the ignition switch to the "OFF" position, or leave it for 15 seconds. **3 long chirps** and **3 parking light flashes** will confirm programming exit.

C. FEATURES PROGRAMMING:



ALARM FEATURE. #1 PROGRAMMING:

1. Turn the Ignition switch from "ON" to "OFF" **3 times** and stay in the "OFF" position.
2. Push the programming switch **2 times** and on **2nd** push hold it until **(1) chirp** followed with a long chirp is heard, then release the switch. You are now in the "**alarm feature #1 programming mode**".
3. Press and release the transmitter button that corresponds to the feature you desire to program.
 - a. The amount of horn chirps and LED pause will indicate the previous setting.
 - b. The factory default settings will always be **[1] LED flash** and **[1] horn chirp**.
4. Press the transmitter button again to change the feature. Simply keep re-pressing the transmitter button until the module advances to your desired programming setting.

Example:

- a. After you hear **(1) chirp**, press the button again and the module will advance to **[2] LED flashes** and **[2] horn chirps**.
- b. Press the button again, the module will advance to **[3] LED flash** and **[3] horn chirps** etc.

ALARM FEATURE #1 PROGRAMMING CHART

Press Transmitter Button	One Chirp with One LED Pulse Factory Default Setting	Two Chirps with Two LED Pulses	Three Chirps with Three LED Pulses	Four Chirps with Four LED Pulses
1 	Chirps off	Chirps on		
2 	Active arming	Passive arming without passive door locking	Passive arming with passive door locking	Active arming with Passive starter disable
3 	Automatic Rearm off	Automatic Rearm on		

PROGRAMMING

ALARM FEATURE #1 PROGRAMMING CHART

Press Transmitter Button	One Chirp with One LED Pulse Factory Default Setting	Two Chirps with Two LED Pulses	Three Chirps with Three LED Pulses	Four Chirps with Four LED Pulses
4 *	45 Second Delay Door Ajar Warning	Instant Door Ajar Warning		
5 +*	Panic with Ignition off	Panic with Ignition on and off	Panic with Ignition on and off. Panic with no time limit	Without Panic function

Exit: Turn ignition switch to the on position, or leave it for 15 seconds. **3 long chirps** and **3 parking light flashes** will confirm programming exit.

DOOR AJAR WARNING (45 SECOND DELAY):





This feature controls the error chirp that is generated if the system is armed with the door trigger active. This is useful in a vehicle that has a dome light delay after the door has been closed. If the system is armed before the dome light has turned "OFF", the security system will generate the door trigger error chirp. Use this feature to disable the door open error chirp

ALARM FEATURE. #2 PRORAMMING:

1. Turn the Ignition switch from "ON" to "OFF" **3 times** and stay in "OFF" position.
2. Push the **valet/program switch 4 times** and hold the **4th** push in until **(2) chirps** followed with **(1) long chirp** is heard then release the **valet/program switch**. You are now in the "**alarm feature #2 programming mode**".
3. Press and release the transmitter button that corresponds to the feature you desire to program.

PROGRAMMING

ALARM FEATURE #2 PROGRAMMING CHART

Press Transmitter Button	One Chirp with One LED Pulse Factory Default Setting	Two Chirps with Two LED Pulses	Three Chirps with Three LED Pulses	Four Chirps with Four LED Pulses
1 	0.9-second door lock pulse	3.5-second door lock pulse	Double pulse unlock	Door lock with "Comfort Feature"
2 	Ignition controlled door lock and unlock	Ignition controlled door lock only	Ignition controlled door unlock only	Without ignition controlled door lock and unlock
3 	Pathway illumination feature "off"	Parking light turns "on" for 30-seconds upon an unlock signal	Parking light turns "on" for 30-seconds upon and unlock signal & 10-seconds upon a lock signal	
4 	Disable the out of range check	Enable the out of range check		

Exit: Turn ignition switch to the "ON" position, or leave it for 15 seconds. **3 long chirps** and **3 parking light flashes** will confirm programming exit.

Comfort Feature:

Some vehicles have a special comfort feature. When you lock the driver's door with the key, and hold the key in the door for 5 to 7 seconds all the windows in the vehicle will roll up. If you would like to operate this feature with the remote transmitter, you can program the alarm feature # **2-1** to "Comfort Feature".

ALARM FEATURE. # 3 PROGRAMMING:

1. Turn the Ignition switch "ON" to "OFF" **3 times** and stay in "OFF" position.
2. Push the **valet/program switch 6 times** and hold it in on the **6th** push until **3 chirps** followed with a long chirp is heard and the LED turns on then release the **valet/program switch**. You are now in the **Alarm feature # 3 programming mode**.
3. Press and release the transmitter button that corresponds to the feature you desire to program.

PROGRAMMING



ALARM FEATURE #3 PROGRAMMING CHART

Press Transmitter Button	One Chirp with One LED Pulse Factory Default Setting	Two Chirps with Two LED Pulses	Three Chirps with Three LED Pulses	Four Chirps with Four LED Pulses
1				
2	H7/8 Lt. Green/Black Wire = Factory Security Disarm Signal/Unlock Output	H7/8 Lt. Green/Black Wire = Dual Pulse Door (Shock Sensor	H7/8 Lt. Green/Black Wire = Start Status Output Bypass)	
3	H5/8 White/Wire =1 Pulse Activate	H5/8 White/Wire = 2 Pulses Activate	H5/8 White/Black Wire = 3 Pulses Activate	
4				
5	H7/6 Violet/Black Wire Channel 4 Output= Momentary Output	H7/6 Violet/Black Wire Channel 4 Output= Latched Output	H7/6 Violet/Black Wire Channel 4 Output= Latched output & reset with ignition "on"	H7/6 Violet/Black Wire Channel 4 Output= Timer programm- ing (set to any interval between 1 sec. and 2 min.)
6	H7/5 Black/Red Wire Channel 5 Output = Momentary Output	H7/5 Black/Red Wire Channel 5 Output= Latched Output	H7/5 Black/Red Wire Channel 5 Output= Latched output and reset with ignition "on"	H7/5 Black/Red Wire Channel 5 Output= Timer programm- ing (set to any interval between 1 sec. and 2 min.)
7	H7/2 Black/Violet Wire Channel 6 Output= Momentary Output	H7/2 Black/Violet Wire Channel 6 Output= Latched Output	H7/2 Black/Violet Wire Channel 6 Output= Latched Output and reset with ignition "on"	H7/2 Black/Violet Wire Channel 6 Output= Timer programm- ing (set to any interval between 1 sec. and 2 min.)

Exit: Turn ignition switch to the on position, or leave it for 15 seconds. 3 long chirps and 3 parking light flashes will confirm programming exit.

PROGRAMMING

Channels 4 (5 / 6) Timer Control Output Programming.

1. Turn the Ignition switch from "ON" to "OFF" **3 times** and stay in "OFF" position.
2. Push the **valet/program switch** **6 times** and hold it in on the **6th** push until **3 chirps** followed with **(1) long chirp** is heard and the LED turns on then release the **valet/program switch**. You are now in the "**alarm feature # 3 programming mode**".
- 3.-a. Press and release the transmitter  and *** buttons** together **4 times**, **[4] LED flashes** and **[4] siren or horn chirps** will indicate you are in "**Channel 4 Timer Programming mode**".
- 3-b. Press and release the transmitter  and *** buttons** together **4 times**, **[4] LED flashes** and **[4] siren or horn chirps** will indicate you are in "**Channel 5 Timer Programming mode**".
- 3-c. Press and release the transmitter  and *** buttons** together **4 times**, **[4] LED flashes** and **[4] siren or horn chirps** will indicate you are in "**Channel 6 Timer Programming mode**".
4. Press and hold the **valet/program switch**, the timer will immediately start.
5. When the desired interval has passed, release the **valet/program switch**. **(1) long chirp** for confirmation. **(Set to any interval between 1 second and 2 minutes)**

Note 1:

If your built-in timer controls windows or a sunroof in your vehicle **DO NOT** change the timer setting! This requires installer-only programming. Changing the value will adversely effect operation and may cause damage.

Note 2:

Momentary output The momentary output selection will provide a negative signal from the **Channel 4 (5/6)** output immediately when the **Channel 4 (5/6)** button is pressed and will continue until the button is released.

Latched output The latched output selection will provide a negative signal as soon as the **Channel 4 (5/6)** button is pressed and will continue until the button is pressed again

Latched output / reset with ignition The latched / reset with ignition output selection operates just like the latched output but will reset or stop when the ignition is turned on.

Ground Output During Start (Crank) This wire will provide a 200 mA ground output while the starter output of the remote start unit is active. This output can be used to activate the Crank Low/Bulb Test wire found in some GM vehicles. This wire is also referred to as the ECM wake up wire in some vehicles.







PROGRAMMING

REMOTE START FEATURE PROGRAM MODE.

START FEATURE. # 1 PROGRAMMING:

1. Turn the Ignition from "ON" to "OFF" **3 times** and stay in "OFF" position.
2. Push the valet switch **8 times** and hold it in on the **8th** push until **(4) chirps** followed with **(1) long chirp** is heard and the LED turns on then release the **valet/program switch**. You are now in the **"start feature #1 programming mode"**.
3. Press and release the transmitter button that corresponds to the feature you desire to program.

START FEATURE CHART #1

Press Transmitter Button	One Chirp with One LED Pulse Factory Default Setting	Two Chirps with Two LED Pulses	Three Chirps with Three LED Pulses	Four Chirps with Four LED Pulses
1  	Gasoline Engine			
	Diesel Engine with Wait-to-Start Light (H5/5 Grey/Black Wire must be connected)	Diesel Engine without Wait-to-Start Light 10 seconds warm-up timer	Diesel Engine without Wait-to-Start Light 15 seconds warm-up timer	Diesel Engine without Wait-to-Start Light 20 seconds warm-up timer
2 	20 Minute Run Time	30 Minute Run Time	5 Minute Run Time	10 Minute Run Time
3 	Factory Alarm Disarm with Channel 3 On	Without this Feature		
4 	Constant Parking Light Output	Flashing Parking Light Output		
5 	Without this Feature	Door Lock Before Start	Door Lock After Shut-Down	Door Lock Before Start and Door Lock After Shut-Down

PROGRAMMING

Press Transmitter Button	One Chirp with One LED Pulse Factory Default Setting	Two Chirps with Two LED Pulses	Three Chirps with Three LED Pulses	Four Chirps with Four LED Pulses
6 +	Press - Button=Activate Remote Start	Press + Button=Activate Remote Start	Press button = Activate Remote Start	
7 +	Fahrenheit Display for Temperature	Celsius Display for Temperature		
8 +	Temperature-Control I Starting OFF	Temperature-Control Starting 5F (-15C)	Temperature-Control Starting - 4F (-20C)	Temperature-Control Starting - 22F (-30C)

Exit: Turn Ignition to "ON" position, or leave it for 15 seconds. **3 long chirps** and **3 parking light flashes** to confirm exit.

SAFE START (Child safety mode)

Factory defaults setting to press the button twice to start the vehicle. Programming this feature to eliminate an accidental remote start, when kids enter this transmitter, it requires: The user press the transmitter and buttons at the same time to start the vehicle.

START FEATURE. # 2 PRORAMMING:

1. Turn the ignition switch from "OFF" to "ON" **3 times** and stay in the "OFF" position.
2. Push the **valet/program switch 10 times** and hold it in on the **10th** push until **(5) chirps** followed with **(1) long chirp** is heard and the then release the **valet/program switch**. You are now in the **start feature #2 programming mode**.
3. Press and release the transmitter button that corresponds to the feature you desire to program.

PROGRAMMING

START FEATURE CHART #2

Press Transmitter Button	One Chirp with One LED Pulse Factory Default Setting	Two Chirps with Two LED Pulses	Three Chirps with Three LED Pulses	Four Chirps with Four LED Pulses
1	Exit the programming mode. (3 long chirps and 3 parking light flashes to confirm this exit.)			
2 +	Engine Checking Voltage	Engine Checking TACH / RPM Learning Mode	Engine Checking Negative Oil Sensor	Engine Checking Positive Oil Sensor
3	Start Timer: 0.6-second	0.8-second (2 chirps), 1.0-second (3 chirps) 1.2-second (4 chirps), 1.4-second (5 chirps), 1.6-second (6 chirps), 1.8-second (7 chirps), 2.0-second (8 chirps), 3.0-second (9 chirps), 4.0-second (10 chirps).		
4	Low check level	Hi check level		
5 * + *	Start or stop the system for TESTING AND ADJUSTMENT			
6 + *	3 Hour Time Start	2 Hour Time Start		
7 + *	The Vehicle without Turbo (The system cannot be Arm with the engine is running.	The Vehicle has aftermarket Turbo timer installed. The system can be Arm with engine running and the shock sensor will be by-pass as long as the engine is running.	Built-in Turbo Timer Control is Active. Press + * buttons at the same time to control engine running one minute.	Built-in Turbo Timer Control is Active: Press + * buttons at the same time to control Engine running three minutes.
		Five chirps=Built-in Turbo Timer Control is Active/Press and * buttons at the same time to control Engine running five minutes.		

PROGRAMMING

Exit: Press the **🔒 button** on the transmitter **3 long chirps** and **3 parking light flashes** will confirm programming exit.

IMPORTANT NOTE: You must program the "Tach Signal" before trying to remote start.

ENGINE CHECKING TACH. / RPM LEARNING

1. Turn the ignition switch from "OFF" to "ON" **3 times** and stay in "OFF" position.
2. Push the **valet/program switch 10 times** and hold it until **five chirps** followed with a long chirp is heard then release the **valet/program switch**.
3. Press and release the transmitter **🔒** and **🔒** buttons at the same time twice **[2] LED flashes** and **[2] chirps** will confirm the system in features "**RPM learning mode**".
4. Within 10 seconds, start the vehicle with the key. (While the engine is running, the parking lights and LED light will flash, if they don't, please check your **VIOLET/WHITE** wire connection.)
5. Press and hold the **valet switch** for 2 seconds until a long chirp and the LED light flashes constant for two seconds. The RPM signal is now learned.
6. Turn off the ignition switch to stop the engine from running
7. If the crank time on the starter needs adjusted proceed to crank level programming.

CRANK TIME ADJUST / HI OR LOW LEVEL CHECK

1. Press the *** button twice** on the transmitter to start the vehicle.
2. If everything goes well:
 - a. Press the *** button twice** on the transmitter to stop engine running. You have been completed this programming successfully.
 - b. Press **🔒 button** on the transmitter to exit the program mode. There will be **3 long chirps** and **(3) parking light flashes** for confirmation.
3. If the crank time is too short, (Engine not running, before the starter stops cranking):
 - a. Press the *** button twice** on the transmitter to turn the ignition off. Press **🔧 button** on the transmitter to set proper "**Check Level**" to Hi position. **[2] LED flashes** and **[2] chirps** will confirm this setting.
 - b. Repeat the step1 - 4.

PROGRAMMING

4. If the crank time is too long, (Engine already successfully running, while the starter remains engaged):
 - a. Press the *** button** twice on the transmitter to stop the engine running. Press **Ⓜ button** on the transmitter to set proper **"Check Level"** to Low position. [1] LED flash and [1] chirp will confirm this setting
 - b. Repeat the step1 – 4.

ENGINE CHECKING VOLTAGE

1. Turn the ignition switch from **"ON"** to **"OFF"** (3) times and stay in **"OFF"** position.
2. Push the **valet/program switch (10) times** and hold it until (5) chirps followed by a long chirp is heard then release the **valet/program switch**.
3. Press the transmitter **🔒** and **🔓** buttons at the same time to set the **"Voltage Checking Type"**. (2) LED flashes and (2) chirps will confirm this setting.

Once you complete step 3, you can adjust and test "Start Timer" as below:

START TIMER PROGRAMMING (TESTING AND ADJUSTING THE CRANK TIME)

1. Press the *** button twice** on the transmitter to start the vehicle.
2. If everything goes well: Wait for 15 seconds:
 - a. If the engine still running.
 - I. Press the *** button twice** on the transmitter to stop the engine from running. You have completed this programming successfully.
 - II. Press **🔒 button** on the transmitter to exit the program mode. There will be **3 long chirps** and **(3) parking light flashes** for confirmation.
 - b. If the engine shut down after the vehicle has been started.
 - I. Press the *** button twice** on the transmitter to turn the ignition off.
 - II. Press **Ⓜ button** on the transmitter to set **"Check Level"** to LOW position. [1] LED flash and [1] chirp will confirm this setting.
 - III. Repeat the step1 – 2.

PROGRAMMING

3. If the crank time is too long, (The engine is successfully running, while the starter is still cranking):
 - a. Press the *** button twice** on the transmitter to stop the engine.
 - b. Press **🔒 button** on the transmitter to set proper **"Start Timer"**. The chirp and LED pauses will confirm you have entered the start timer mode (Decreasing the start timer is necessary.)
 - c. Repeat the step1 – 4.
4. If the crank time is too short, (The engine is not running and the starter did not engage long enough)
 - a. Press the *** button twice** on the transmitter to turn the ignition **"OFF"**
 - b. Press **🔒 button** on the transmitter to set proper **"Start Timer"**. The chirp and LED pauses will confirm you have entered the start timer mode. (Increasing the Start timer is necessary.)
 - c. Repeat the step1 – 4.

ENGINE CHECKING OIL SENSOR

1. Turn the Ignition switch from **"ON"** to **"OFF"** **3 times** and stay in **"OFF"** position.
2. Push the **valet/program switch 10 times** and hold it in on the **10th** push until **(5) chirps** followed with **(1) long chirp** is heard and the LED turns on then release the **valet/program switch**.
3. Press the transmitter **🔒** and **🔒 buttons** at the same time to set the **"Engine Checking Oil Sensor"**. **[3] / [4] LED flashes** and **[3] / [4] chirps** will confirm this setting.

Once you complete step 3, you can adjust and test **"Start Timer"** as below:

START TIMER PROGRAMMING: (TEST and ADJUST)

Press the *** button twice** on the transmitter to start the vehicle.

1. If everything goes well:
 - a. Press the *** button twice** on the transmitter to stop engine running. You have been completed this programming successfully.
 - b. Press **🔒 button** on the transmitter to exit the program mode. There will be **(3) long chirps** and **(3) parking light flashes** for confirmation.

PROGRAMMING

- If the crank time is too long, (Engine already successfully running, while the starter is still cranking):
 - Press the *** button twice** on the transmitter to stop engine from running.
 - Press the **🔒 button** on the transmitter to set proper the **"Start Timer"**. The chirp and LED pauses will confirm you are in the start timer mode. (Decreasing the Start Time is necessary.)
 - Repeat the step1 – 4.
- If the crank time is too short (The engine is not running and the starter did not engage long enough)
 - Press the *** button twice** on the transmitter to turn off the ignition.
 - Press **🔒 button** on the transmitter to set proper **"Start Timer"**. The chirps and LED pauses will confirm you are in the start timer mode. (Increasing the start timer is necessary.)
 - Repeat the step1 – 4.

RETURN TO FACTORY DEFAULT SETTING:

Note: This will reset all alarm features to factory default settings

- Turn the ignition from "ON" to "OFF" (3) times and stay in the "OFF" position.**
- Push the valet switch (12) times and hold it until (6) short chirps followed by a long chirp is heard.**

Press and hold the **🔒** and **🔧** buttons at the same time on the transmitter for 6 seconds, there will be a confirmation of **(6)short chirps with (3) long chirps** to confirm the system **Alarm Features #1, #2 and #3 programming** all return to factory default settings.

Note: This will reset all remote starter features to factory default settings

- Press the **🔧 button** first, within **3 seconds** press and hold the **🔒** and **🔧 buttons** at the same time on the transmitter for 6 seconds, there will be a confirmation of **(6) short chirps followed by 3 long chirps** to confirm the system **"Start Feature #1 and #2 programming"** will return to factory default settings.

PROGRAMMING

To Exit: Turn Ignition to the on position, or leave it for **15 seconds. 3 long chirps and 3 parking light flashes** will confirm programming exit.

SHUTDOWN DIAGNOSTICS

The unit has the ability to diagnose and report the cause of the last shutdown on the remote start system.

Enter:

1. Turn the Ignition switch to the **"ON"** position.
2. Press the **🔑 button** on the transmitter.
3. The LED will now report the last system shutdown by flashing for one minute in the following grouped patterns.

LED Flashes	Shutdown Mode	
1	(-) Safety Shutdown Input (Hood)	1.Close the Hood 2.Check H5/1 GREY wire connection
2	(+) Safety Shutdown Input (Brake) or Hand Brake (if installed or Neutral Safety Switch input fail	1.Set the Hand Brake (if installed) 2.Check H5/2 BROWN/RED wire connection. 3.Move the Enable Toggle Switch to "ON" position. (if installed) 4.Move the gear selector to "Park"/"Neutral" position. 5.Check H5/3 THIN BLACK wire connection.
3	No RPM (Engine Checking TACH) or Low Voltage. (Engine Checking Voltage) or Oil Sensor (Engine Checking Oil Sensor)	Check H5/9 VIOLET/WHITE wire connection. Program the "CHECK LEVEL" from "Hi Check Level" to "Low Check Level" Check H5/9 VIOLET/WHITE wire connection.
4	Over-rev	
5	System timed out	
6	Transmitter	

PROGRAMMING

LED Flashes	Shutdown Mode	
7	Tach. Signal has not been learned	Re-learning the RPM (Start feature #2-2)
8	The procedure of the Engine start memorizing for the vehicle with manual transmission gear is not completed.	Check Operation Manual # Remote Start Operation B section.

TESTING YOUR INSTALLATION

Caution!! The follow procedure must be performed after the installation of the remote start device. It is the responsibility of the installing technician to complete these tests. Failure to test the unit in the following manner may result in personal injury, property damage, or both.

1. Test the brake shutdown circuit: With the vehicle in park (P), start the vehicle using the remote transmitter. Once the engine is running, press the brake pedal. The vehicle should shut down immediately. If the vehicle continues to run, check the brake circuit **BROWN/RED** wire (**H5/2**) connection.
2. Test the hood safety shutdown circuit: Start the vehicle using the remote transmitter. Once the engine is running, pull the hood release and raise the hood. The vehicle should shut down immediately. If the vehicle continues to run, check the hood pin **GREY** wire (**H5/1**) connection.

NEUTRAL START SAFETY TEST:

1. Set the vehicle parking brake.
2. Block the drive wheels to prevent vehicle movement.
3. Sitting in the vehicle, turn the ignition switch to on or run position, but do not start the engine.
4. Step on the brake pedal and shift the gear selector into "**DRIVE**" (D).
5. Put your foot over the brake pedal but do not press down on it. Be ready to step on the brake to shut down the remote start device.

TESTING YOUR INSTALLATION

6. Start the vehicle using the remote transmitter.
 - a. If the starter does not engage, the test is complete.
 - b. If the starter engages, immediately step on the brake pedal to shut down the system and check your **VIOLET** wire **H1/1** starter output connection. The heavy gauge **VIOLET** wire must be connected to the ignition switch side of the neutral safety switch. If the vehicle you are working on does not have an Electrical Neutral Safety Switch, it will be necessary to reconfigure the remote starts wiring to accommodate this vehicle. The information concerning the mechanical neutral safety switch provided below will help you to determine if the vehicle you are working on has this type of safety switch and will provide alternate wiring methods to accommodate this situation.

MECHANICAL NEUTRAL SAFETY SWITCH CONSIDERATIONS:

Mechanical neutral safety switch configurations differ slightly in that they do not offer the same level of safety when installing a remote start device. Often when the ignition switch is turned off while the gear selector is in any position other than park or neutral, the mechanical function will not allow the key to be turned to the start position or removed from the ignition cylinder. This configuration prevents mechanical operation while the vehicle is in gear but offers no consideration for the electrical operation. Because of this potential problem, your installation requires the additional connection of a safety wire from the remote start device to the vehicle **PARK/NEUTRAL** ECM input or the vehicle key in sensor wire. This connection will prevent remote start operation if the key is left in the ignition switch regardless of the gear selector position.

PARK/NEUTRAL ECM INPUT:

The Park/Neutral ECM input is the preferred method of installation. This not only maintains the integrity of the factory circuit but is also the easiest to install, providing the vehicle you are working on has this ECM input.

The installation required for this application (shown below), is a slight reconfiguration of the control switch wiring. Shown is a typical GM Park/Neutral ECM input circuit. To connect the remote start unit to the GM Park/Neutral ECM input:

1. Locate the **ORANGE/BLACK** reference wire in the "C2" connector found at the ECM in GM B Body vehicles or, locate the equivalent reference wire in the vehicle you are installing the remote start unit in.

TESTING YOUR INSTALLATION

2. Connect the **THIN BLACK** Neutral Safety Switch wire (**H5/3**) to this reference wire.

NOTE: If the optional remote starter enable toggle switch is installed, connect the one side of the switch to this reference wire the other side of to the **THIN BLACK** Neutral Safety Switch wire (**H5/3**) of the remote start unit. The reference diagram below shows a typical GM B Body ECM reference wire and how to connect it to the remote start unit.

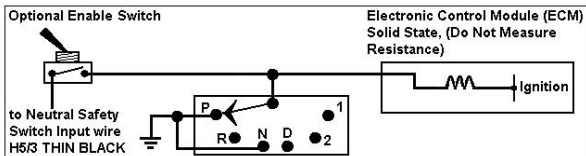

KEY IN SENSOR CIRCUITS:

If the vehicle you are working on does not have or you cannot locate the ECM reference wire, there are two alternatives available. Although not preferred, the vehicle key in sensor may be reconfigured to allow a margin of safety and will prevent the vehicle with a mechanical neutral start switch from starting in gear.

WE ADVISE THAT YOU MAINTAIN THE FACTORY CIRCUIT WHENEVER POSSIBLE. The following two circuits may be used only if the above circuit is not available.

NOTE: When completing an installation using either of the following key in sensor circuits, if the operator inserts the ignition key while the vehicle is running under the control of the remote start, the vehicle will shut down. This must be explained to the operator as it is in contrast to the normal operation of a vehicle utilizing an electrical neutral start switch and is inconsistent with the operator's manual.

Method 1 will allow the safety required for the remote start unit and prevent the vehicle from starting while in any gear other than Park or Neutral while the key is in the ignition cylinder however, if the key is left in the ignition switch and the door is left opened, the added relay will be energized causing a 150mA drain on the battery.

TESTING YOUR INSTALLATION

Method 2 will allow the safety required for the remote start unit and prevent the vehicle from starting while in any gear other than Park or Neutral while the key is in the ignition cylinder however, the original factory key in chime module will not alert the owner that the key has been left in the ignition switch. In addition, this may also affect other warning tones such as the light on reminder.

Note:

Additional information concerning key in sensor methods 1 and 2 are listed below and should be reviewed before considering either alternative.

METHOD 1

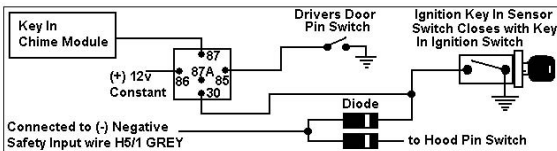

To connect to the key in sensor as shown in method 1:

- Locate the control wire that connects the driver's door pin switch to the key in sensor switch.
- Cut this wire and connect the ignition cylinder side to a chassis ground.
- Locate the key in sensor switch wire that connects the chime module to the ignition cylinder.
- Cut this wire and connect the ignition cylinder side to terminal 30 of a P&B VF45F11 or equivalent relay.
- Connect the cathode (striped) side of a 4003 series diode to this same wire, and connect the (non striped) side to the negative safely input wire **(GREY) (H5/1)** of the remote start unit.
- Connect terminal 86 of the relay to a fused + 12 volt constant battery source.
- Connect terminal 87 of the relay to the chime module side of the previously cut wire in step D.
- Connect terminal 85 of the relay to the driver's door side of the pin switch wire previously cut in step B.

TESTING YOUR INSTALLATION

Note: A second **4003 series diode** may be required to maintain the integrity of the hood open, shut down circuit. If this is the case, it must be installed as shown in the diagram above. The anode (Non Stripped) side must be connected to the **GREY wire (H5/1)** of the remote start unit. The cathode (Striped) side must be connected to the hood pin switch.

METHOD 2

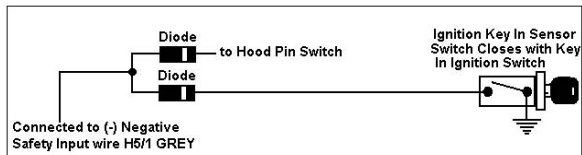

To connect to the key in sensor circuit as shown for method 2:

- Locate the control wire that connects the driver's door pin switch to the key in sensor switch.
- Cut this wire and connect the ignition cylinder side to chassis ground.
- Locate the key in sensor switch wire that connects the chime module to the ignition cylinder.
- Cut this wire and connect the ignition cylinder side to the Remote Start Negative Safety Shut down wire **GREY (H5/1)**, using a **4003 series diode** as shown above.

Note: A second **4003 series diode** may be required to maintain the integrity of the hood open, shut down circuit. If this is the case, it must be installed as shown in the diagram above. The anode (Non Striped) side must be connected to the **GREY wire (H5/1)** of the remote start unit. The cathode (Striped) side must be connected to the hood pin switch.

AFTER THE CONNECTION OF THE NEUTRAL START SAFETY WIRE AS INDICATED IN ANY OF THE PREVIOUS ALTERNATE CONFIGURATIONS, THIS CIRCUIT MUST BE TESTED FOR OPERATION.

Retest by following the steps outlined in the NEUTRAL START SAFETY TEST shown in this manual.

WARRANTY

Bulldog Warranty Information

All Bulldog models have a Limited Lifetime Warranty on the main control module.

All parts excluding the control module have a two year warranty against defects in workmanship, This includes shock sensors, remote transmitters and sirens. The control module will be repaired or replaced at our discretion for up to a 12 month period at no charge. After 12 months a \$30.00 fee will be charged for repair or replacement of the control module.

Removal and reinstallation charges are not the responsibility of JBS Technologies, LLC the manufacturer of Bulldog Security. Warranty registration must be completed within 14 days of the original date of purchase. Registration can be mailed in or performed on line at **www.bulldogsecurity.com**. JBS Technologies makes no warranty against the theft of a vehicle or its contents. This warranty only extends to the original system purchaser in the vehicle it was originally installed in.

Limitation of Remedies

The purchasers remedy is limited to the repair or replacement of the unit and in no event shall exceed the purchase price. Incidental, consequential and or indirect damages are expressly disclaimed. No person or entity is authorized to alter or amend this limited lifetime warranty.

©2004 JBS Technologies
225 Technology Way • Steubenville, OH 43952
www.bulldogsecurity.com
Made in Taiwan